

# Cuisinart®

## INSTRUCTION AND RECIPE BOOKLET



**Cuisinart® Convection  
Microwave Oven with Grill**

**CMW-200**

For your safety and continued enjoyment of this product, always read the instruction book carefully before using.

# IMPORTANT SAFETY INSTRUCTIONS

**WARNING:** To reduce the risk of burns, electric shock, fire, injury to persons, or exposure to excessive microwave energy and when using electrical appliances basic safety precautions should be followed including the following:

1. Read all instructions before using the appliance.
2. Read and follow the specific warning: PRECAUTIONS TO AVOID POSSIBLE EXPOSURE TO EXCESSIVE MICROWAVE ENERGY, page 3.
3. This appliance must be grounded. Connect only to properly grounded outlet. See GROUNDING INSTRUCTIONS, page 4.
4. Install or locate this appliance only in accordance with the COUNTERTOP INSTALLATION, page 6.
5. Some products such as whole eggs and sealed containers – for example, closed glass jars – can explode and should not be heated in this oven.
6. Use this appliance only for its intended use as described in this manual. Do not use corrosive chemicals or vapors in this appliance. This oven is specifically designed to heat or cook food. It is not designed for industrial or laboratory use.
7. As with any appliance, close supervision is necessary when it is used by children.
8. Do not operate this appliance if it has a damaged cord or plug, if it is not working properly or if it has been damaged or dropped.
9. This appliance should be serviced only by qualified service technicians. Contact 1-800-726-0190.
10. Do not cover or block any openings on the appliance.
11. Do not store or use this appliance outdoors.
12. Do not use this product near water, for example, near a kitchen sink, in a wet basement, near a swimming pool, or similar locations.
13. Do not immerse cord or plug in water.
14. Keep cord away from heated surfaces.

15. Do not let cord hang over edge of table or counter.
16. When cleaning surfaces of door and oven that come together on closing the door, use only mild, nonabrasive soaps or detergents applied with a sponge or soft cloth.
17. To reduce the risk of fire in the oven interior:
  - a) Do not overcook food. Carefully attend appliance when paper, plastic, or other combustible materials are placed inside the oven to facilitate cooking.
  - b) Remove wire twist-ties from paper or plastic bags before placing bag in oven.
  - c) If materials inside the oven ignite, keep oven door closed, turn oven off, and disconnect the power cord, or shut off power at the fuse or circuit breaker panel.
  - d) Do not use the interior for storage purposes. Do not leave paper products, cooking utensils or food in the oven when not in use.
18. **Liquids such as water, coffee, or tea can be overheated beyond the boiling point without appearing to be boiling. This is called delayed eruptive boiling. Visible bubbling or boiling when the container is removed from the microwave oven is not always present. THIS COULD RESULT IN VERY HOT LIQUIDS SUDDENLY BOILING OVER WHEN THE CONTAINER IS DISTURBED OR A UTENSIL IS INSERTED INTO THE LIQUID.**
19. To reduce the risk of injury to persons:
  - a. Do not use straight-sided containers with narrow necks. Use a wide-mouth container.
  - b. Stir liquid both before and halfway through heating it.
  - c. Do not overheat liquid.
  - d. Use extreme care when inserting a spoon or other utensil into the container. This may also cause delayed eruptive boiling.
  - e. After heating, allow the container to stand in the microwave oven for at least 20 seconds before removing the container.

# SAVE THESE INSTRUCTIONS. FOR HOUSEHOLD USE ONLY.

## PRECAUTIONS TO AVOID POSSIBLE EXPOSURE TO EXCESSIVE MICROWAVE ENERGY

1. Do not attempt to operate this oven with the door open as this can result in harmful exposure to microwave energy. It is important not to break or tamper with the safety interlocks.
2. Do not place any object between the oven front face and the door or allow soil or cleaner residue to accumulate on sealing surfaces.
3. Do not operate the oven if it is damaged. It is particularly important that the oven door closes properly and that there is no damage to the door (for example, make sure that it is not bent); hinges and latches (for example, make sure that they are not broken or loosened); door seals and sealing surface.

4. The oven should not be adjusted or repaired by anyone except properly qualified service personnel. If the microwave unit is not kept clean, its surface could be degraded and lead to a hazardous situation.

## SPECIAL CORD SET INSTRUCTIONS

### DANGER - Electric Shock Hazard

Touching some of the internal components can cause serious personal injury or death. Do not disassemble this appliance.

### WARNING - Electric Shock Hazard

Improper use of the grounding can result in electric shock. Do not plug into an outlet until appliance is properly installed and grounded.

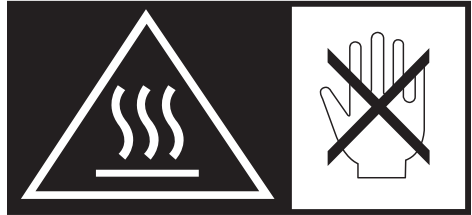

	<b>WARNING</b> RISK OF FIRE OR ELECTRIC SHOCK DO NOT OPEN	
<b>WARNING: TO REDUCE THE RISK OF FIRE OR ELECTRIC SHOCK, DO NOT REMOVE COVER (OR BACK) NO USER-SERVICEABLE PARTS INSIDE REPAIR SHOULD BE DONE BY AUTHORIZED SERVICE PERSONNEL ONLY</b>		

# GROUNDING INSTRUCTIONS

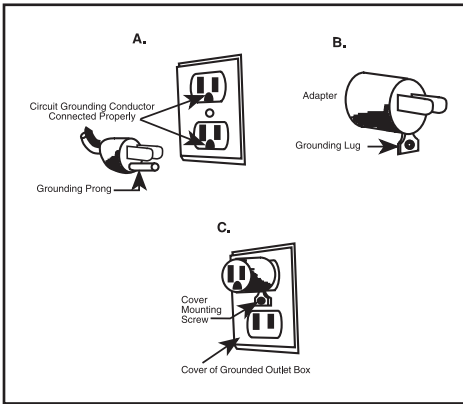

This appliance must be grounded. In the event of an electrical short circuit, grounding reduces the risk of electric shock by providing an escape wire for the electric current. This appliance is equipped with a cord with a grounding wire and grounding plug. The plug must be plugged into an outlet that is properly installed and grounded. Consult a qualified electrician or serviceman if the grounding instructions are not completely understood or if doubt exists as to whether the appliance is properly grounded. If it is necessary to use an extension cord, use only a 3-wire extension cord that has a 3-pronged grounding plug, and a 3-slot receptacle that will accept the plug on the appliance.

1. A short power-supply cord is provided to reduce the risks resulting from becoming entangled in or tripping over a longer cord.
2. Longer cord sets or an extension cord should not be used unless the following precautions are followed (see 3, below).
3. If a long cord or extension cord is used:
  - The marked electrical rating of the cord set or extension cord should match the rating of the appliance.
  - The extension cord must be a grounding-type 3-wire cord.
  - The longer cord should be arranged so that it will not drape over the countertop or tabletop where it can be pulled on by children or tripped over.

# CONTENTS

- Important Safety Instructions . . . . . 2
- Precautions to Avoid Possible Exposure to Excessive Microwave Energy . . . . . 3
- Special Cord Set Instructions . . . . . 3
- Grounding Instructions . . . . . 4
- Introduction . . . . . 4
- Important Safeguards . . . . . 5
- Specifications . . . . . 5
- Parts and Accessories . . . . . 6
- Installation . . . . . 6
- About Your Oven . . . . . 7
- About Cookware . . . . . 8
- Materials You Can Use in Microwave Oven . . . . . 8
- Materials to be Avoided in Microwave Oven . . . . . 8
- Containers . . . . . 9
- About Microwave Cooking . . . . . 9
- About Food . . . . . 10
- About Safety . . . . . 10
- Operating Instructions . . . . . 11
- Special Features . . . . . 16
- Other Features . . . . . 17
- Memory . . . . . 18
- Care and Cleaning . . . . . 18
- Troubleshooting . . . . . 19
- Warranty . . . . . 20

# INTRODUCTION

Cuisinart is about to change the way you cook! With the debut of this new Convection Microwave Oven and Grill, you have a broader range of cooking options than ever before. Get ready to enjoy the speed of a microwave, the quality of convection baking, and all the top-browning talents of a grill. Best of all, your new oven is engineered with preset controls and combination settings to take the guesswork out of temperature and timing. You can even program it to automatically switch from one function to another. And it all happens right on your countertop...time to get cooking!

# IMPORTANT SAFEGUARDS

To reduce the risk of fire, electric shock, injury to persons or exposure to excessive microwave oven energy when using your appliance, follow basic precautions, including the following:

1. The oven must be placed on a level surface.
2. The glass turntable and turntable assembly must be in the oven during cooking. Handle the glass turntable carefully and place cookware on it gently to avoid possible breakage.
3. Incorrect use of browning dish may cause the turntable to break. See information about cookware you can use, page 8-9.
4. Use only the correctly specified bag size when using the preset popcorn program.
5. The oven has several built-in safety switches to ensure that the power remains off when the door is open. Do not tamper with these switches.
6. Do not operate the microwave oven empty. Operating the oven with no food or food that is extremely low in moisture can cause fire, charring or sparking.
7. Do not cook bacon directly on the turntable. Excessive local heating of the turntable may cause the turntable to break.
8. Do not heat baby bottles or baby food in the microwave oven. Uneven heating/hotspots may occur and cause injury.
9. Do not heat narrow-necked containers, such as syrup bottles.
10. Do not attempt to deep-fry in your microwave oven.
11. Do not attempt home canning in this microwave oven, as it is impossible to be sure all contents of the jar have reached boiling temperature.
12. Do not use this microwave oven for commercial purposes. This microwave oven is made for household use only.
13. Failure to maintain the oven in a clean condition could lead to deterioration that could adversely affect the life of the appliance and possibly result in a hazardous situation.

# SPECIFICATIONS

Model: CMW-200
Rated Voltage: 120V-60Hz
Rotate Input M/W Power: 1500W
Rated Output Power: 1000W
Rated Input Power Grill: 1100W
Rated Input Power Convection: 1500W
Oven Capacity: 32 L
Turntable Diameter: Ø12.40 inches
External Dimensions: 20.4" x 18.9" x 12.4"
Approximate Net Weight: 40.8 lbs

# PARTS AND ACCESSORIES

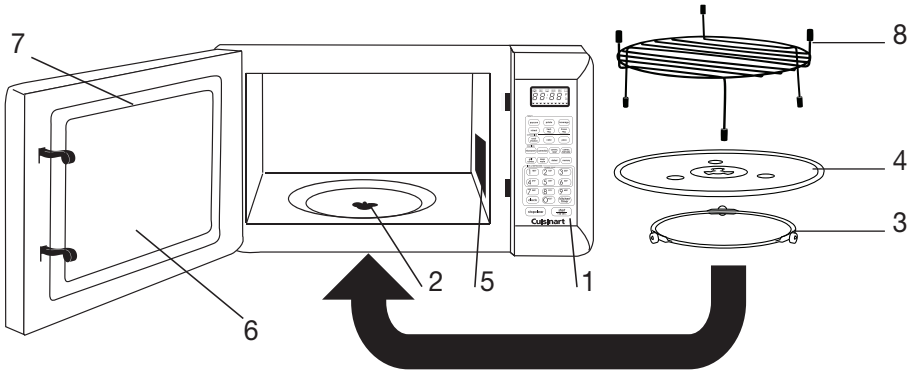

Remove all packing material and accessories. Examine the oven for any damage such as dents or broken door. Do not install if oven is damaged.

1. Control panel
2. Turntable shaft
3. Turntable ring assembly
4. Glass tray
5. MicroGuide (DO NOT REMOVE)
6. Observation window
7. Door assembly
8. Grill rack

## TURNTABLE INSTALLATION

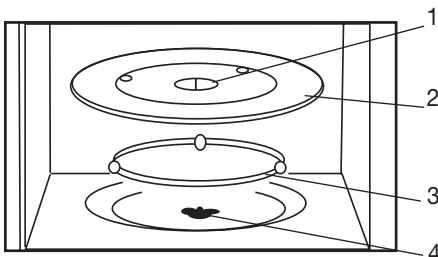

1. Hub (underside) of glass tray
  2. Glass tray
  3. Turntable ring assembly
  4. Turntable shaft
- Never place the glass tray upside down. The glass tray should never be restricted.
  - Both glass tray and turntable ring assembly must always be used during cooking.

- All food and containers of food are always placed on the glass tray for cooking.
- If glass tray or turntable ring assembly cracks or breaks, contact your retail store where purchased or Cuisinart customer service, 1-800-726-0190. See page 20 for details.

## COUNTERTOP INSTALLATION

1. Select a level surface that provides enough open space for the intake an/or outlet vents.
2. Do not remove the legs from the bottom of the oven.
3. Leave a minimum clearance of 12 inches (30cm) above the oven. A minimum clearance of 3.0 (8cm) inches is required between the oven and any adjacent walls. One side must be open.
4. Remove any protective film found on the microwave oven cabinet surface.
5. Do not remove the light brown mica cover MicroGuide that is attached to the oven cavity. The MicroGuide shields and directs the wave action.
6. Blocking the intake and/or outlet openings can damage the oven.

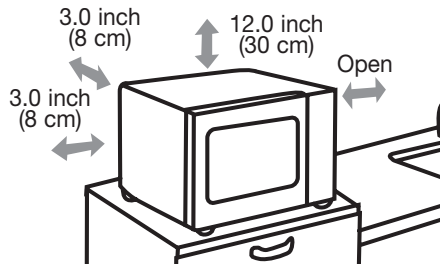

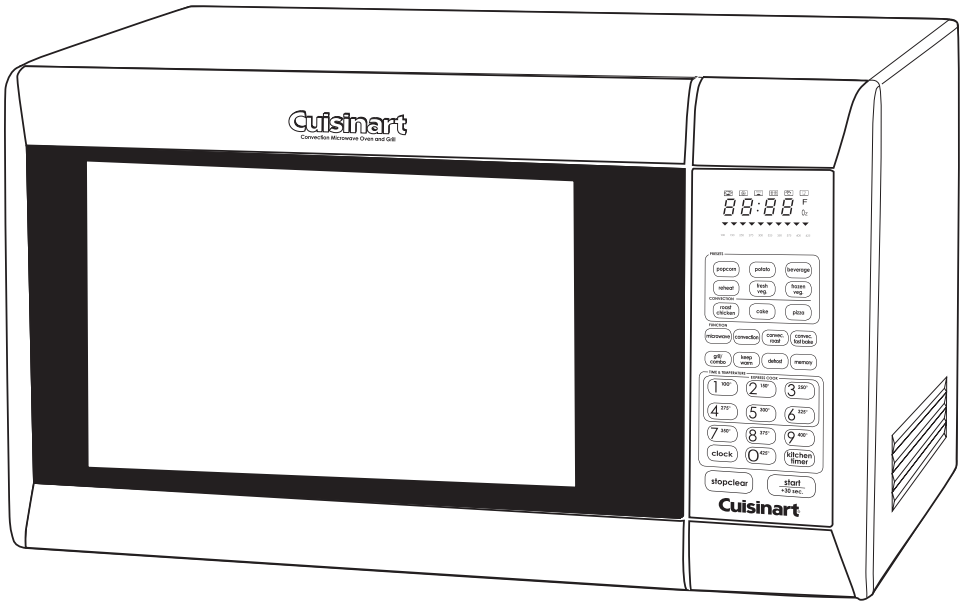

7. Operation of microwave oven may cause interference to other electronic equipment in the vicinity.
8. Plug your oven into a standard household outlet. Be sure the voltage and the frequency are the same as the voltage and the frequency on the rating label.

**WARNING:** Do not install oven over a range cooktop or other heat-producing appliance. If improperly installed near or over a heat source, the oven could be damaged and the warranty would be void.

The accessible surfaces may be hot during operation.

## ABOUT YOUR OVEN

**NEVER** use the oven without the turntable and support or turn the turntable over so that a large dish can be placed in the oven. The turntable will turn both clockwise and counterclockwise.

**ALWAYS** have food in the oven when it is on to absorb the microwave energy. When using the oven at power levels below 100%, you may hear the magnetron cycling on and off. It is normal for the exterior of the oven to be warm to the touch when cooking or reheating. Condensation is a normal part of microwave cooking. Room

humidity and the moisture in food will influence the amount of moisture that condenses in the oven.

Generally, covered foods will not cause as much condensation as uncovered ones. Vents on the oven back must not be blocked.

After using **convection, grill/combination or Convec. Roast**, you will hear the sound of the cooling fan. The fan may operate depending on the oven temperature.

Be aware that, unlike microwave-only ovens, convection microwave ovens have a tendency to become hot.

The oven is hot whenever the top grill, or both grill or convection symbols are lighted in the display.

The oven is for food preparation only. It should not be used to dry clothes or newspapers.

Your oven is rated 1000 watts for the microwave by using the IEC Test Procedure method. In using recipes or package directions, check food a minute or two before the minimum time and add time accordingly.

Cookware	Microwave	Convection	Combination
Heat-Resistant Glass, Glass-Ceramic (Pyrex®, Fire King®, Corning Ware®, etc.)	Yes	Yes	Yes
Metal	No	Yes	No
Non Heat-Resistant Glass	No	No	No
Microwave-Safe Plastics	Yes	No	Yes
Plastic Films and Wraps	Yes	No	No
Paper Products	Yes	No	No
Straw, Wicker and Wood	No	No	No
Aluminum foil: *Shielding only. Small smooth pieces may be used to cover thin parts of poultry to prevent overcooking. Arcing can occur if foil is too close to oven walls. The foil should be at least 1 inch (2.5cm) away from the oven walls.	Yes*	Yes	Yes
Dinnerware: Microwave safe only. Follow manufacturer's instructions. Do not use cracked or chipped dishes.	Yes	No	No
Oven cooking bags: Follow manufacturer's instructions. Do not close with metal tie. Make slits to allow steam to escape.	Yes	Yes	Yes
Wax Paper Use as a cover to prevent splattering and retain moisture inside.	Yes	No	No

Materials To Be Avoided In A Microwave	
Aluminum tray	May cause arcing. Transfer food to microwave-safe dish.
Food carton with metal handle	May cause arcing. Transfer food to microwave-safe dish.
Metal or metal-trimmed utensils	Metal shields the food from microwave energy. Metal trim may cause arcing.
Metal twist ties	May cause arcing and could cause a fire in the oven.
Paper bags	May cause a fire in the oven.
Plastic foam	Plastic foam may melt or contaminate the liquid inside when exposed to high temperature.
Wood	Wood will dry out when used in the microwave oven and may split or crack.

## ABOUT COOKWARE

It is not necessary to buy all new cookware. Many pieces already in your kitchen can be used successfully in your new convection microwave oven. The chart

above will help you decide what utensils and coverings should be used with each feature. Make sure the utensil does not touch the interior walls during cooking.



# MATERIALS YOU CAN USE IN MICROWAVE

Arcing is sparks or electric flashes that crackle or pop. Arcing can produce heat that is quite intense and can damage the interior of the microwave or containers being used in the microwave. It can also cause fire.

Arcing occurs when metal containers are used in the microwave and can also occur with the use of metal skewers, metal clamps, or twist ties for plastic bags. To prevent arcing, use the charts to determine which materials are microwave safe, or follow instructions from container/wrap manufacturer.

Plastic cookware designed for microwave cooking is very useful, but should be used carefully. Even microwave-safe plastic may not be as tolerant of overcooking conditions as are glass or ceramic materials and may soften or char if subjected to short periods of overcooking. In longer exposures to overcooking, the food and cookware could ignite.

## Follow these guidelines:

Use microwave-safe plastics only and use them in strict compliance with the cookware manufacturer's recommendations.

Do not microwave empty containers.

Do not permit children to use plastic cookware without complete supervision.

# CONTAINERS

## CAUTION: Personal Injury Hazard

Tightly closed containers could explode. Closed containers should be opened and plastic pouches should be pierced before cooking.

There may be certain non-metallic materials that are not safe to use for microwaving. If in doubt, you can test the material/container in question following the procedure below.

## Material/Container Test:

1. Fill a microwave-safe container with 1 cup of cold water (250ml) along with the material or container in question.
2. Cook on maximum power for 30 seconds.

3. Carefully feel the material or container. If it is warm, do not use it for microwave cooking.
4. Do not exceed 1 minute cooking time.

# ABOUT MICROWAVE COOKING

Arrange food carefully. Place thickest areas towards outside of dish.

- Watch cooking time. Cook for the shortest amount of time indicated and add more as needed. Food severely overcooked can smoke or ignite.
- Cover foods while cooking. Check recipe or cookbook for suggestions: paper towels, wax paper, microwave plastic wrap or a lid. Covers prevent splattering and help foods to cook evenly.
- Shield with small flat pieces of aluminum foil any thin areas of meat or poultry to prevent overcooking before dense, thick areas are cooked thoroughly.
- Stir foods from outside to center of dish once or twice during cooking, if possible.
- Turn foods over once during microwaving to speed cooking of such foods as chicken and hamburgers. Large items like roasts must be turned over at least once.
- Rearrange foods such as meatballs halfway through cooking both from top to bottom and from the center of the dish to the outside.
- Add standing time. Remove food from oven and stir, if possible. Cover for standing time which allows the food to finish cooking without overcooking.
- Check for doneness. Look for signs indicating that cooking temperatures have been reached.

## ABOUT FOOD

FOOD	DO	DON'T
Eggs, sausages, nuts, seeds Fruits and vegetables	<ul style="list-style-type: none"> <li>• Puncture egg yolks before cooking to prevent “explosion.”</li> <li>• Pierce skins of potatoes, apples, squash, hot dogs and sausages so that steam escapes.</li> </ul>	<ul style="list-style-type: none"> <li>• Cook eggs in shells.</li> <li>• Reheat whole eggs.</li> <li>• Dry nuts or seeds in shells.</li> </ul>
Popcorn	<ul style="list-style-type: none"> <li>• Use specially bagged popcorn for the microwave oven.</li> <li>• Listen while popping corn for the popping to slow to 1 or 2 seconds.</li> </ul>	<ul style="list-style-type: none"> <li>• Pop popcorn in regular brown bags or glass bowls.</li> <li>• Exceed maximum time on popcorn package.</li> </ul>
Baby food	<ul style="list-style-type: none"> <li>• Transfer baby food to small dish and heat carefully, stirring often. Check temperature before serving.</li> <li>• Put nipples on bottles after heating and shake thoroughly. “Wrist” test before feeding.</li> </ul>	<ul style="list-style-type: none"> <li>• Heat disposable bottles.</li> <li>• Heat bottles with nipples on.</li> <li>• Heat baby food in original jars.</li> </ul>
General	<ul style="list-style-type: none"> <li>• Cut baked goods with filling after heating to release steam and avoid burns.</li> <li>• Stir liquids briskly before and after heating to avoid “eruption.”</li> <li>• Use deep bowl, when cooking liquids or cereals, to prevent boilovers.</li> </ul>	<ul style="list-style-type: none"> <li>• Heat or cook in closed glass jars or air tight containers.</li> <li>• Deep fat fry.</li> <li>• Dry wood, gourds, herbs or wet papers.</li> </ul>

## ABOUT SAFETY

Check foods to see that they are cooked to the United States Department of Agriculture’s recommended temperatures.

Temp	Food
160°F	For fresh pork, ground meat, boneless white poultry, fish, seafood, egg dishes and frozen prepared food.
165° F	For leftover, ready-to-reheat refrigerated, and deli and carryout “fresh” food
170° F	White meat of poultry (with bone)
180° F	Dark meat of poultry

To test for doneness, insert a meat thermometer into a thick or dense area away from fat or bone. NEVER leave the thermometer in the food during cooking, unless it is approved for microwave oven use.

- ALWAYS use potholders to prevent burns when handling utensils that are in contact with hot food. Enough heat from the food can transfer through utensils to cause skin burns.
- Avoid steam burns by directing steam away from the face and hands. Slowly lift the farthest edge of a dish’s covering and carefully open popcorn and oven cooking bags away from the face.
- Stay near the oven while it’s in use and check cooking progress frequently so that there is no chance of overcooking food.
- NEVER use the interior of the oven for storing cookbooks or other items.
- Select, store and handle food carefully to preserve its high quality and minimize the spread of foodborne bacteria.
- Keep MicroGuide cover clean. Food residue can cause arcing and/or fires.
- Use care when removing items from the oven so that the utensil, your clothes or accessories do not touch the safety door latches.

- Keep aluminum foil used for shielding at least 1 inch away from walls, ceiling and door.
- Use potholders and be careful when using convection, convection roast, convection fast bake and grill, as cabinet, interior and door, may be too hot to touch.

## OPERATING INSTRUCTIONS

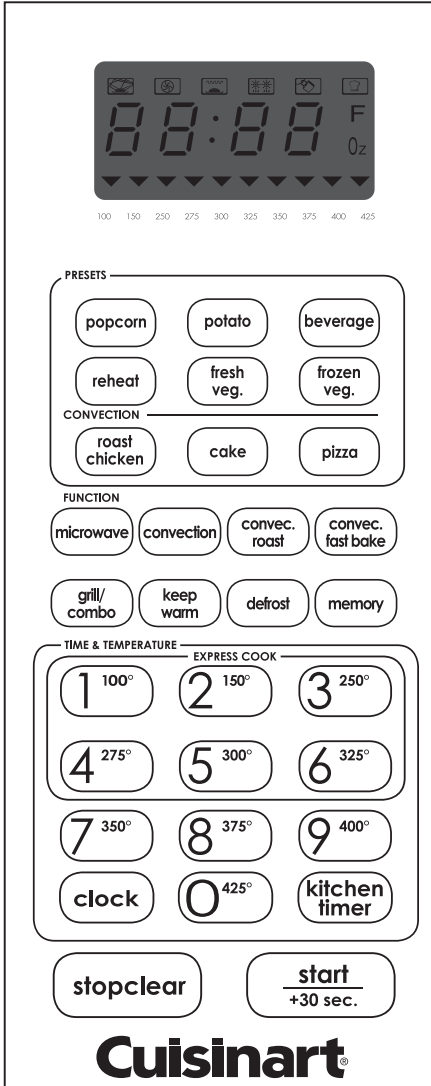

Before operating your new microwave oven, make sure you read and understand this Instruction booklet completely.

Before the oven can be used, follow these procedures:

1. Plug in the oven. Close the door.
2. Touch the **Stop/Clear** pad. **0 : 00** will appear.
3. Set clock.

## TO SET THE CLOCK

When the microwave oven is plugged in, the oven will display **0:00**, and buzzer will beep once. The input time entered should be between 1:00-12:59.

**Example: To set 12:30AM or PM**

1. Press **Clock** and the buzzer will beep once.
2. Press the number keys: **1, 2, 3, 0.**
3. Press **Clock** to finish setting.

**NOTE:** if the clock is not set, **0 : 00** is displayed.

This is a 12-hour clock. To correct a setting, touch the **Stop/Clear** pad and re-enter the time.

**NOTE:** If the electrical power supply to your microwave oven is interrupted during cooking, the program will be erased. After the power is restored, simply touch "**Clock**" and reset the clock for the correct time of day.

## TO SET THE KITCHEN TIMER

1. Press **Kitchen Timer**. **0 : 00** is displayed.
2. Press the number keys to set the time within the range of 99 minutes and 99 seconds.

**Example:** To set kitchen timer for 12 minutes and 15 seconds, press 1, 2, 1, 5 in turn.

3. Press **Start/+30SEC.** to confirm; time will count down on display.
4. When time has elapsed, the buzzer will beep 5 times.

**Note:** When the kitchen timer is engaged, the oven will not start with any program and the oven light will not light.

## STOP/CLEAR

Touch the **Stop/Clear** pad to:

1. Erase if you make a mistake during programming.
2. Cancel kitchen timer.
3. Stop the oven temporarily during cooking (touch once).
4. Return the time of day to the display.
5. Cancel a program during cooking (touch twice).

## MICROWAVE COOKING

Your oven can be programmed for 99 minutes 99 seconds (99:99). Always enter the seconds after the minutes, even if they are both zeros. There are 10 preset power levels. Press **Microwave** to change or choose the power level.

Using lower power levels increases the cooking time. This is recommended for foods such as cheese, milk and long slow cooking of beef. Consult cookbook or recipes for specific recommendations.

- a. Press **Microwave** repeatedly to select microwave power. Power level will be displayed.
- b. Press number keys to enter the cooking time; the maximum cooking time is 99 minutes and 99 seconds.
- c. Press **START/+30SEC.** to start cooking, and the remaining cooking time will be displayed. Microwave indicators will be flashing in the display.

Note: In the process of cooking, if the **STOP/CLEAR** button is pressed once for pause, twice to turn off command. If there is no operation within a minute of being interrupted, the oven will turn off automatically.

If you want to set the power level to something other than high, press the power button repeatedly until desired power level is reached. Power counts down from high to low. Use number buttons to set a cooking time. You can set a time from one second to 99 minutes 99 seconds.

Example: To use 90% microwave power to cook for 5 minutes.

1. Press **Microwave** once, then oven will display **PL10, Micro**. Indicator will light.

2. Press **Microwave** again to choose 90% power. The oven will display **PL9**.
3. Press the number buttons of **5, 0, 0** in order. The oven will display 5:00 indicating number of minutes.
4. Press **Start/+30SEC.** to start cooking, will light and the **: Micro**. Indicator will flash.

Press Microwave To Select Desired Power Level	Approx. % Of Power	Common Words For Power Levels
PL 10	100%	High
PL 9	90%	
PL 8	80%	
PL 7	70%	Medium High
PL 6	60%	
PL 5	50%	Medium
PL 4	40%	
PL 3	30%	Medium Low/Defrost
PL 2	20%	
PL 1	10%	Low

## EXPRESS COOKING

This feature provides a shortcut to programming your oven. Power level is always at 100%. You can select either 1 to 6 minutes or 30-second increments.

- a. Select a cooking time from 1 to 6 minutes by pressing Express Cook number pads 1 to 6.
- b. Oven will instantly start when number pad is pressed.
- c. To increase the cooking time by 30-second increments, press **START/+30SEC.**
- d. To cook for 30-second increments only, press **START/+30SEC.**

## KEEP WARM

This feature allows you to keep food warm without overcooking.

Press **Keep Warm** once. The oven will display 100F.

Press **Keep Warm** twice. The oven will display 150F.

Press **Start/+30SEC.** button to start heating.

## DEFROST

This feature allows you to defrost by weight or by time.

### Defrost by Weight

1. Press **Defrost** once. The oven will display **dEF1. Micr.** Defrost indicators will light.
2. Press the number keys to set defrosting weight within the range of 4 to 100 ounces.
3. Press **Start/+30SEC.** to start defrosting.

### Defrost by Time

1. Press **Defrost** twice. The oven will display **dEF2. Micr.** Defrost indicators will light.
2. Press the numbers on the number pad to set defrosting time. The max time is 99 minutes 99 seconds.
3. Press **Start/+30 SEC.** to start defrosting.

## MULTI-STAGE COOKING

Advanced technology lets you program oven to automatically shift functions. Switch between 2 or 3 functions in a sequence you select.

Up to three stages of cooking can be set.

If one of the stages is defrosting, it should be the first stage.

The buzzer will ring once after each stage of cooking is completed and the next stage will begin.

Note: Express Cook and Keep Warm cooking cannot be set as one part of multi-stage cooking.

Example I: Defrosting for 10 minutes; cooking with 100% microwave power for 3 minutes and then 70% microwave power for 5 minutes. The steps are as follows:

1. Press **Defrost** twice to set time.
2. Press number keys **1, 0, 0, 0** to set defrost time.
3. Press **Microwave** once, **PL10** is displayed.
4. Press number keys **3, 0, 0** to set the cooking time.

5. Press **Microwave** four times to select 70% microwave power. **PL7** is displayed:
6. Press number keys **5, 0, 0** to set the cooking time.
7. Press **Start/+30SEC.** to start multi-stage cooking.

Example II: To use multi-stage cooking with grill feature: You can defrost a casserole, heat it up in the microwave and grill it to melt the cheese or top-brown the casserole. Defrost for 10 minutes; bake with microwave at 100% power for 5 minutes and grill for 1 minute:

1. Press **Defrost** twice to set time.
2. Press number keys **1, 0, 0, 0** to set defrost time.
3. Press **Microwave** once, **PL10** is displayed.
4. Press number keys **5, 0, 0** to set the cooking time.
5. Press **Grill/Comb** key once; **G-1** is displayed.
6. Press number keys **1, 0, 0** to set the cooking time.
7. Press **Start/+30SEC.** to start multi-stage cooking.

## CONVECTION COOKING

With convection cooking, you can use your Cuisinart oven as a traditional oven. The microwave function is not used.

During convection cooking, a heating element is used to raise the temperature of the air inside the oven. A fan gently circulates this heated air throughout the oven, over and around the food, producing golden brown exteriors and rich moist interiors.

Because the heated air is kept constantly moving, preventing a layer of cooler air from developing around food, some foods cook faster than in regular oven cooking. Also, foods lose less moisture and are able to retain nutrients better.

This oven can be programmed for ten different cooking temperatures for up to 99 minutes, 99 seconds.

## THINGS YOU SHOULD KNOW ABOUT CONVECTION

- The oven should not be used without the turntable in place, and the turntable should never be restricted so that it cannot rotate. You may remove the turntable when preheating the oven and when preparing food to be cooked directly on the turntable. Be sure to replace it in oven before cooking.
- Do not cover turntable or rack with aluminum foil. It interferes with airflow that cooks food.
- Round pizza pans are excellent cooking utensils for many convection-only items. Choose pans that do not have extended sides.
- You can preheat the oven to the appropriate temperature before placing the food in the oven.
- When preparing conventional oven recipes, it is important to check food about 5 to 10 minutes before the expected finish time, due to variables such as the temperature of the food when first placed in the oven, quantity of food in the oven, and your preferred level of “doneness”, etc.
- If not completely done, continue cooking in oven until the food reaches the expected level of “doneness.”
- Use the provided grill rack for multi level cooking.
- Best results are achieved when foods are baked/roasted on the provided grill rack to ensure even airflow.
- The lower rack position is used for most baking and roasting tasks. Use the upper rack position for grilling and browning.

### When Roasting Meat and Poultry

- Meats and poultry are best when roasted directly on the rack. We recommend placing a shallow dish or pie plate below the rack to catch any drippings for gravy and to reduce/minimize splatter.
- Less tender cuts can be roasted and tenderized using oven cooking bags.

## CONVECTION SETTINGS

There are two convection settings: convection with preheating and convection without preheating.

Your oven can be programmed to combine preheating and convection cooking. You can preheat to the convection temperature desired.

### A. Convection Cooking with Preheating

For example, you want to preheat to 350° F. and then cook 25 minutes at the same temperature.

1. Press **Convection** once. The oven will display **100F** and **Conv** indicator will light.
2. Press the number key **7** to set the temperature to 350°.
3. Press **Start/+30SEC.** to start preheating.
4. The temperature will flash while the oven reaches the desired temperature. The buzzer will beep twice to remind you to open the door, put food into the oven, then close the door.
5. Press number keys **2, 5, 0, 0** to set the cooking time. The maximum time is 99 minutes 99 seconds.
6. Press **Start/+30SEC.** to start cooking. Cooking time will count down on the display.

#### NOTE:

- Cooking time cannot be entered until the preheating temperature is reached. When the temperature is reached, place the food in the oven and enter the cooking time.
- If the time is not entered within 5 minutes, the oven will stop preheating. The signal will beep 5 times to alert you.

### B. Convection Cooking (Without Preheating Function)

1. Press **Convection** once. The oven will display **100F**.
2. Press the convection temperature key to select the temperature you need.
3. Press the **Convection** button to confirm the temperature
4. Press the number keys to set cooking time. The maximum time is 99 minutes 99 seconds.
5. Press **Start/+30SEC.** to start cooking. Cooking time will count down.

## Special Convection Settings

Your oven also offers the option of combination cooking, using microwave energy along with convection cooking. You cook with speed and accuracy, while browning and crisping to perfection. All that is necessary is to enter cooking time. Use this option as indicated to ensure baking success.

The Convection Roast uses both the even heating of convection cooking and the fast cooking of the microwave to produce roasted meats and poultry that are evenly browned and juicy on the inside.

The Convection Fast Bake function also uses a combination of microwave and convection cooking best used for casseroles and baked dishes.

Best results are achieved when foods are baked/roasted on the provided grill rack to ensure even airflow.

### Convection Roast

1. Press **Convec. Roast** once. The oven will display **325F**.
2. Press the temperature key to select the temperature you need.
3. Press **Convec. Roast** to confirm the temperature.
4. Press the number keys to set cooking time.
5. Press **Start/+30SEC.** to start cooking. Cooking time will count down.

### NOTE:

During Convection Roast or Convection Fast Bake, some metal baking utensils may cause arcing when they come in contact with the turntable, oven walls or rack. Arcing is a discharge of electricity that occurs when microwaves come in contact with metal. See page 8 – “Cookware You Can Use”.

### Convection Fast Bake Cooking

1. Press **Convec. Fast Bake** once. The oven will display **100F**.
2. Press the temperature key to select the temperature you need.
3. Press **Convec. Fast Bake** to confirm the temperature.
4. Press the number keys to set cooking time. The maximum time is 99 minutes 99 seconds.

5. Press **Start/+30SEC.** to start cooking. Cooking time will count down.

## GRILLING

You can program up to 3 automatic cooking options. G-1 is 100% grilling and G-2 and G-3 are a combination of microwave and grill.

Grill/Combination	Display	Microwave	Grill
1	G-1		100%
2	G-2	30%	70%
3	G-3	55%	45%

### Grill/Microwave and Grill Combination Cooking

1. Press the **Grill/Comb.** button once to choose the grill function. G-1 will be displayed
2. Press twice or three times to choose the combination function with G-2 or G-3 will be displayed.
3. Set the cooking time. Example: To set 12 minutes 50 seconds, press number keys **1, 2, 5, 0.**
4. Press **Start/+30SEC.** to start cooking. The cooking time counts down. : will light and Grill indicator will flash.

### THINGS YOU SHOULD KNOW ABOUT GRILLING

- Your Cuisinart Microwave Convection Oven with Grill comes with a reversible grill rack. On one side the legs are shorter than on the other side allowing you to place food closer or further away from the grilling heat.
- When you are halfway through the grilling time, the oven will signal twice. The oven does not stop but if you choose you can open the door to turn over your food to grill on the other side.
- Turn the food over, close the door and press **Start/+30SEC.** to continue cooking.
- Using a preheated rack can give a grilled appearance to steaks, hot dogs etc.
- Foods, such as vegetables or frozen snack foods, can be grilled directly on the turntable.



# SPECIAL FEATURES

## EXPRESS COOK (preset settings)

All of the auto settings take the guesswork out of preparing many popular foods. Each food is cooked using the best cooking method and the proper cooking time. Refer to the Express Cook guides on this page and page 16.

## SELECT FUNCTIONS

The Express Cook selections are divided into microwave and convection settings.

Express Cook Guide-MICROWAVE		
Menu	Weight (Oz)	Display
Popcorn	1.75 oz	1.75 oz
	3.00 oz	3.00 oz
	3.50 oz	3.50 oz
Potato	1 (about 6.5-8 oz)	1
	2 (about 13-16 oz)	2
	3 (about 26-32 oz)	3
Beverage	1 (about 8.8 oz)	1C
	2 (about 17.6 oz)	2C
	3 (about 26.4 oz)	3C
Reheat	8.00 oz	Sou1
	12.00 oz	Sou2
	8-12 oz	Cas 1
	12-24 oz	Cas 2
	1 dinner plate	1 PL
Fresh Vegetable	4.0 oz	1 C
	8.00 oz	2 C
	16.00 oz	3 C
Frozen Vegetable	4.0 oz	1 C
	8.0 oz	2 C
	16.0 oz	3 C

**For microwave Express Cook settings press:**

- Popcorn, Potato, Beverage, Reheat, Fresh Vegetable or Frozen Vegetable to choose the function you need

- Enter the weight (lbs or oz) or amount (cups or units) of food you need.
- Press **Start/+30SEC.** to start cooking.
- The final cooking result will vary according to the food's initial temperature, shape, quality, etc. Check food for temperature after cooking. If additional time is needed, press **START/30SEC.** to add additional cooking time in 30-second increments until desired result is reached.

## Popcorn

- Use only popcorn packaged for microwave oven use.
- Try several brands to decide which brand you like the best.
- Do not try to pop unpopped kernels.

## Potato

- Pierce, place on turntable lined with a paper towel. See instructions in the chart.
- After cooking, remove from oven, wrap in aluminum foil and let stand 5 to 10 minutes, depending on the size of the potato.

## Beverage

After heating, stir contents; test for desired heat. Repeat if necessary.

## Reheat

### Soup (1-3 cups)

Use this setting to reheat refrigerated liquid foods such as soups and sauces. Cover with microwave-safe lid or microwave-safe plastic wrap. After cooking, let stand for 2 to 3 minutes.

### Casserole (1-3 cups)

Use this setting to reheat refrigerated cooked solid food (pasta, rice). Cover with microwave-safe lid or microwave-safe plastic wrap. After cooking, let stand for 2 to 3 minutes.

### Dinner Plate (1 plate)

- Use this setting to reheat precooked foods from refrigerator.
- Place meaty portions and bulky vegetables toward outside of plate.
- Cut large items like baked potatoes into smaller pieces.



- Flatten foods such as mashed potatoes and other dense foods.
- Cover with microwave-safe lid or microwave-safe plastic wrap. **ONE PLATE ONLY.**

After cooking, check food for desired temperature. The center bottom of the plate should be very hot. If not, continue heating using time and power level and or **START/30SEC.** Allow to stand, covered, for 1 to 2 minutes.

### Fresh and Frozen Vegetables

- For beans carrots, corn and peas, add 1 tablespoon of water per cup.
- For broccoli, brussel sprouts, cabbage and cauliflower, cook immediately after washing with no additional water.
- Cover with microwave-safe lid for tender vegetables.
- If you like tender crisp vegetables, double or triple the measured quantity per setting. For example, use 2 cups or 3 cups of zucchini but only select 1 cup.
- After cooking, remove from oven, stir, cover with microwave-safe lid and let stand 3 to 5 minutes before serving.
- Do not add water, cover with lid or plastic wrap. After cooking, stir and let stand, covered for 3 minutes.

### For convection Express Cook settings press:

- Roast Chicken, Cake or Pizza to choose the function you need.
- Enter the weight (lbs or oz) or amount (cups or units) of food you need.
- Press **Start/+30SEC.** to start cooking.

Express Cook Guide - CONVECTION		
Menu	Weight (Oz)	Display
Roast Chicken	3.0 lbs.	3.0 L
	3.5lbs	3.5 L
	4.0 lbs	4.0 L
	4.5lbs	4.5 L
Cake	about 16 -18oz (1 box mix)	CA
Pizza	15-22 oz. (small)	SLL
	25-32 oz. (large)	LGE

### Roast Chicken

- Place the chicken breast side up on on the grill rack .
- Place rack on turntable.
- Place a microwave-safe shallow dish or pieplate underneath the rack to catch any drippings of gravy and to minimize spatter.
- After roasting, remove from oven, tent with foil and let stand 5 to 10 minutes before carving and serving.
- Internal temperature of white meat should be 170°F, and of dark meat 180°F.

### Cake

Ideal for packaged cake mix or your own recipe for 8-inch or 9-inch pans. Prepare batter according to directions and place in greased and floured pans.

- **This preset will automatically preheat the oven to 350 degrees.**
- The display will show PHE while the oven is preheating.
- When it reaches the selected temperature, it will beep.
- Shut the door, press **Start/+30SEC.** once and the baking time will begin. The display will show 350 degrees. When completed the oven will beep.
- Cool before frosting and serving.

TIP: In order to bake both layers of a two layer cake, at the same time, use the grill rack positioned at higher level. Place one pan on the bottom of the oven on top of the glass turntable, and place the second pan on the top of the rack.

### Pizza

- Remove from package and unwrap.
- Place on grill rack. Place grill rack on turntable.
- Settings are for small (SLL) 7-inch to 9-inch diameter or large (LGE) 10-inch to 12-inch diameter.

## OTHER FEATURES

### CHILD LOCK

The child lock prevents unwanted oven operation. The oven can be set so that the control panel is deactivated or locked.

## TO LOCK

- Press **Stop/Clear** for 3 seconds.
- There will be a long beep indicating that the child lock has been activated.
- The lock icon will appear.
- The keypad will not be able to be used.

## TO UNLOCK

- To unlock, press **Stop/Clear** for 3 seconds.
- There will be a long beep indicating that the microwave oven is unlocked.
- The lock symbol will disappear.

## TO CHECK POWER DURING COOKING

- Press **Convection, Microwave, Grill/Combo** to check the responding power, and the power will be displayed for 2 to 3 seconds.
- To check time during cooking, press **Clock**. The time will be displayed for 2-3 seconds.

## MEMORY

You can enter up to three cooking procedures, each with one or two stages of cooking, into the oven's memory. They will be numbered 1, 2 and 3 and will be saved for selection at any time. If the power is interrupted, the memory will have to be reset.

### To save a procedure in memory:

For example: Set the following procedure as memory 2. Cook at 50% PL for 3 minutes and 20 seconds, then cook at 100% PL for 2 minutes 15 seconds.

Press **Memory** and the oven will display 1 to 3.

Press **Memory** twice for Memory 2.

Press **Microwave** 6 times to select PL at 50%.

Press number keys **3-2-0** to enter the cooking time.

To set the second stage of this preset press **Microwave** once to select PL at 100%.

Press number keys **2-1-5** in order to select the cooking time.

**To save:** Press **Memory** to save the memory program.

Or press **Start/+30SEC.** to start cooking and save the program automatically.

### To run a procedure that has been saved previously:

- Press **Memory** until the procedure's number (1, 2 or 3) appears in the display.
- Press **Start/+30Sec.** to start cooking on this saved preset.

### NOTE:

- Express Cook cooking cannot be saved as memory.
- If oven is unplugged or power is cut off, memory will not be saved and will have to be reset.

## CARE AND CLEANING

The premium stainless steel used in your oven's interior is exceptionally easy to clean. This nonporous, sanitary surface will not absorb odors and repels food particles. All other parts of the oven, both inside and out, can be quickly cleaned, following the simple directions below.

### Helpful Hints

An occasional thorough wiping with a solution of baking soda and water keeps the inside fresh.

Unplug the cord before cleaning any part of this oven.

### How to clean the inside walls, floor, inside window, metal and plastic parts on the door

Some spatters can be removed with a paper towel and others may require a damp cloth.

Remove greasy spatters with a sudsy cloth, then rinse with a damp cloth. Do not use abrasive cleaners or sharp utensils on oven walls.

To clean the surface of the door and the surface of the oven that come together upon closing, use only mild, non-abrasive soaps or detergents using a sponge or soft cloth. Rinse with a damp cloth and dry.

Never use a commercial oven cleaner on any part of your microwave.

### Removable turntable and turntable shaft and ring assembly

To prevent breakage, do not place the turntable in water just after cooking. Let it

cool, then wash it carefully in warm, sudsy water or in the dishwasher. The turntable and shaft can be broken if dropped. Remember, do not operate the oven without the turntable, turntable shaft and ring assembly in place.

### How to Clean the Outside

Do not use cleaners containing ammonia or alcohol on the microwave oven. Ammonia or alcohol can damage the appearance of the microwave.

Clean the outside of the microwave with a sudsy cloth. Rinse with a damp cloth and then dry. Wipe the window clean with a damp cloth.

### Control Panel and Door

Wipe with a damp cloth. Dry thoroughly. Do not use cleaning sprays, large amounts of soap and water, abrasives or sharp objects on the panel—they can damage it.

Some paper towels can also scratch the control panel.

### Door Surface

It is important to keep the area clean where the door seals against the microwave. Use only mild, non-abrasive detergents applied with a clean sponge or soft cloth. Rinse well.

### Power Cord

If the cord becomes soiled, unplug and wash with a damp cloth. For stubborn spots, sudsy water may be used, but be certain to rinse with a damp cloth and dry thoroughly before plugging cord into outlet.

## TROUBLESHOOTING

TROUBLE	POSSIBLE CAUSE	POSSIBLE REMEDY
Oven will not start	a. Electrical cord is not plugged in. b. Door is open. c. Wrong operation is set.	a. Plug into the outlet. b. Close the door and try again. c. Check instructions.
Arcing or sparking	a. Materials to be avoided in Microwave oven were used. b. The oven is operated when empty. c. Spilled food remains in the cavity.	a. Use microwave-safe cookware only. b. Do not operate with oven empty. c. Clean cavity with wet towel.
Unevenly cooked foods	a. Materials to be avoided in microwave oven were used. b. Food is not defrosted completely. c. Cooking time, power level is not suitable. d. Food is not turned or stirred.	a. Use microwave-safe cookware only. b. Completely defrost food. c. Use correct cooking time, power level. d. Turn or stir food.
Overcooked foods	Cooking time, power level is not correct.	Use correct cooking time, power level.
Undercooked foods	a. Materials to be avoided in microwave oven were used. b. Food is not defrosted completely. c. Oven ventilation ports are restricted. d. Use correct cooking time, power level.	a. Use microwave-safe cookware only. b. Completely defrost food. c. Check to see that oven ventilation ports are not restricted. d. Cooking time, power level is not correct.
Improper defrosting	a. Materials to be avoided in microwave oven were used. b. Cooking time, power level is not correct. c. Food is not turned or stirred.	a. Use microwave-safe cookware only. b. Use correct cooking time, power level. c. Turn or stir food.

## **WARRANTY LIMITED THREE-YEAR WARRANTY**

This warranty is available to consumers only. You are a consumer if you own a Cuisinart® Convection Microwave Oven with Grill that was purchased at retail for personal, family or household use. Except as otherwise required under applicable law, this warranty is not available to retailers or other commercial purchasers or owners.

We warrant that your Cuisinart® Convection Microwave Oven with Grill will be free of defects in materials and workmanship under normal home use for 3 years from the date of original purchase.

We suggest you complete and return the enclosed product registration card promptly to facilitate verification of the date of original purchase. However, return of the product registration card does not eliminate the need for the consumer to maintain the original proof of purchase in order to obtain the warranty benefits. In the event that you do not have proof of purchase date, the purchase date for purposes of this warrant will be the date of manufacture.

If your Cuisinart® Convection Microwave Oven with Grill should prove to be defective within the warranty period, we will repair it, or if we think necessary, replace it. To obtain warranty service, simply call our toll-free number 1-800-726-0190 for additional information from our Customer Service Representatives, or send the defective product to Customer Service at Cuisinart, 150 Milford Road, East Windsor, NJ 08520.

To facilitate the speed and accuracy of your return, please enclose \$15.00 for shipping and handling of the product. Please pay by check or money order (California residents need only supply proof of purchase and should call 1-800-726-0190 for shipping instructions).

NOTE: For added protection and secure handling of any Cuisinart® product that is being returned, we recommend you use a traceable, insured delivery service. Cuisinart cannot be held responsible for in-transit damage or for packages that are not delivered to us. Lost and/or damaged products are not covered under warranty. Please be sure to include your return address, daytime phone number, description of the product defect, product model # (located on bottom of product), original date of purchase, and any other information pertinent to the product's return.

Your Cuisinart® Convection Microwave Oven with Grill has been manufactured to the strictest specifications and has been designed for use with the authorized accessories and replacement parts. This warranty expressly excludes any defects or damages caused by accessories, replacement parts, or repair service other than those that have been authorized by Cuisinart. This warranty does not cover any damage caused by accident, misuse, shipment or other ordinary household use. This warranty excludes all incidental or consequential damages. Some states do not allow the exclusion or limitation of these damages, so they may not apply to you.

### **CALIFORNIA RESIDENTS ONLY:**

California law provides that for In-Warranty Service, California residents have the option of returning a nonconforming product (A) to the store where it was purchased or (B) to another retail store which sells Cuisinart products of the same type. The retail store shall then, at its discretion, either repair the product, refer the consumer to an independent repair facility, replace the product, or refund the purchase price less the amount directly attributable to the consumer's prior usage of the product. If the above two options do not result in the appropriate relief to the consumer, the consumer may then take the product to an independent repair facility if service or repair can be economically accomplished.

Cuisinart and not the consumer will be responsible for the reasonable cost of such service, repair, replacement, or refund for nonconforming products under warranty.

California residents may also, according to their preference, return nonconforming products directly to Cuisinart for repair, or if necessary, replacement, by calling our Consumer Service Center toll-free at 1-800-726-0190. Cuisinart will be responsible for the cost of the repair, replacement, and shipping and handling for such products under warranty.

Any other trademarks or service marks referred to herein are the trademarks or Cuisinart Cuisinart® is a registered trademark of Cuisinart

150 Milford Road  
East Windsor, NJ 08520

Printed in China  
www.cuisinart.com

IB-8084